

# NAiS

## 250 mW Slim Power Relay

# LK-S RELAYS

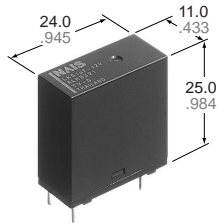

mm inch

### FEATURES

#### 1. High sensitivity: 250mW

The power-saving relay is highly sensitive at the nominal operating power of 250 mW (530 mW power consumption on LK relays).

#### 2. High insulation resistance between contact and coil

- 1) Creepage distance and clearances between contact and coil: Min. 6 mm .236 inch (In compliance with IEC65)
- 2) Surge withstand voltage between contact and coil: 10,000 V or more

#### 3. High noise immunity realized by the card separation structure between contact and coil

#### 4. Popular terminal pitch in AV equipment field

#### 5. Space-saving slim type

Base area: Width 11 × Length 24 mm  
Width .433 × Length .945 inch

#### 6. Conforms to the various safety standards

UL/CSA, VDE, TÜV and SEMKO SEV approved

### SPECIFICATIONS

#### Contact

Arrangement	1 Form A	
Initial contact resistance, max. (By voltage drop 6 V DC 1 A)	Max. 100 mΩ	
Contact material	Silver alloy	
Rating (resistive load)	Nominal switching capacity	5 A 277 V AC
	Max. switching power	1,385 V A
	Max. switching voltage	277 V AC
	Max. switching current	5 A (AC)
Expected life (min. operations)	Mechanical (at 180 cpm)	10 <sup>6</sup>
	Electrical (at 20 cpm) (at rated load)	10 <sup>5</sup>

#### Coil

Nominal operating power	250 mW
-------------------------	--------

#### Remarks

- \* Specifications will vary with foreign standards certification ratings.
- \*<sup>1</sup> Measurement at same location as "Initial breakdown voltage" section.
- \*<sup>2</sup> Detection current: 10mA
- \*<sup>3</sup> Wave is standard shock voltage of  $\pm 1.2 \times 50\mu\text{s}$  according to JEC-212-1981
- \*<sup>4</sup> Excluding contact bounce time.
- \*<sup>5</sup> Half-wave pulse of sine wave: 11 ms; detection time: 10  $\mu\text{s}$
- \*<sup>6</sup> Half-wave pulse of sine wave: 6 ms
- \*<sup>7</sup> Detection time: 10  $\mu\text{s}$
- \*<sup>8</sup> Refer to 5. Conditions for operation, transport and storage mentioned in AMBIENT ENVIRONMENT (Page 24).

#### Characteristics

Max. operating speed	20 cpm (at rated load)	
Initial insulation resistance* <sup>1</sup>	Min. 1,000 MΩ (at 500 V DC)	
Initial * <sup>2</sup> breakdown voltage	Between open contacts	1,000 Vrms for 1 min.
	Between contact and coil	4,000 Vrms for 1 min.
Initial surge voltage between contact and coil* <sup>3</sup>	Min. 10,000 V	
Operate time* <sup>4</sup> (at nominal voltage)	Approx. 7 ms (at 20°C 68°F)	
Release time (without diode)* <sup>4</sup> (at nominal voltage)	Approx. 2 ms (at 20°C 68°F)	
Temperature rise (at 70°C)	Max. 35°C with nominal coil voltage and at 5 A contact carrying current (resistance method)	
Shock resistance	Functional* <sup>5</sup>	Min. 200 m/s <sup>2</sup> {approx. 20 G}
	Destructive* <sup>6</sup>	Min. 1,000 m/s <sup>2</sup> {approx. 100 G}
Vibration resistance	Functional* <sup>7</sup>	10 to 55Hz at double amplitude of 1.5mm
	Destructive	10 to 55Hz at double amplitude of 1.5mm
Conditions for operation, transport and storage* <sup>8</sup> (Not freezing and condensing at low temperature)	Ambient temp.	-40°C to +70°C -40°F to +158°F
	Humidity	5 to 85% R.H.
	Air pressure	86 to 106 kPa
Unit weight	Approx. 12 g .42 oz	

### TYPICAL APPLICATIONS

- Audio visual equipment
- Office equipment
- Home appliances

### ORDERING INFORMATION

Ex. LKS 1a F - 12V

Contact arrangement	Protective construction	Coil voltage(DC)
1a: 1 Form A	F: Flux-resistant type	5, 9, 12, 24V

UL/CSA, TÜV, SEMKO, TV-5 approved type is standard.

- Notes 1. Standard packing Carton: 100 pcs. Case: 500 pcs.  
2. 6 V, 18 V DC types are also available. Please consult us for details.

# LK-S

## TYPES AND COIL DATA (at 20°C 68°F)

Part No.	Nominal voltage, V DC	Pick-up voltage, V DC (max.) (Initial)	Drop-out voltage, V DC (min.) (Initial)	Coil resistance, Ω (±10%)	Nominal operating current, mA (±10%)	Nominal operating power, mW	Maximum allowable voltage, V DC (at 20°C 68°F)
LKS1aF-5V	5	3.5	0.5	100	50	250	6.5
LKS1aF-9V	9	6.3	0.9	324	27.8	250	11.7
LKS1aF-12V	12	8.4	1.2	576	20.8	250	15.6
LKS1aF-24V	24	16.8	2.4	2,304	10.4	250	31.2

## DIMENSIONS

mm inch

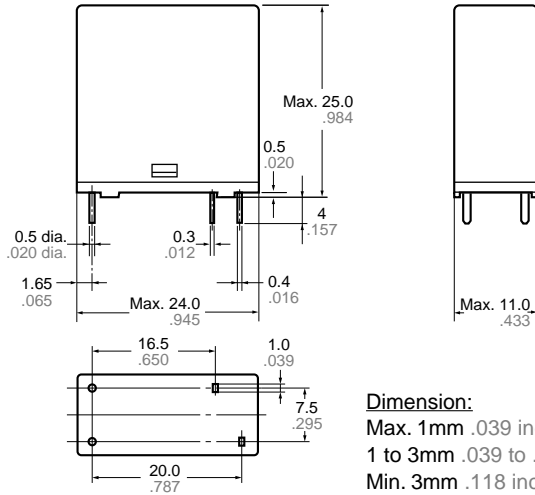

PC board pattern (Bottom view)

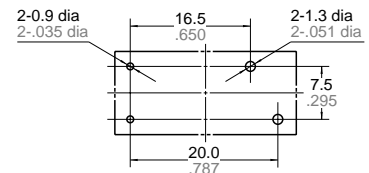

Tolerance: ±0.1 ±.004

Schematic (Bottom view)



## REFERENCE DATA

1. Max. switching power (AC resistive load)

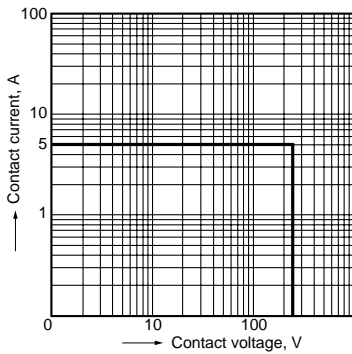

2. Coil temperature rise

Sample: LKS1aF-12V, 6 pcs.  
 Point measured: coil inside  
 Contact current: 0 A, 5 A

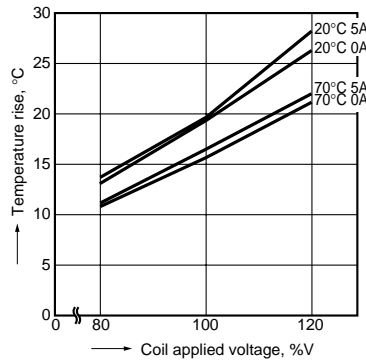

3. Ambient temperature characteristics and coil applied voltage

Contact current: 5 A

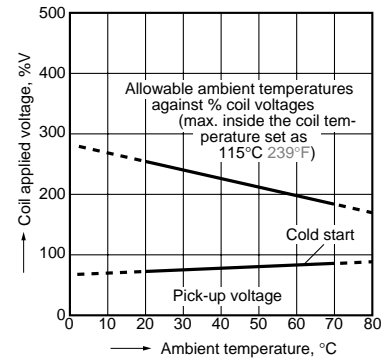

4. Life curve

Operation frequency: 20 times/min.

(ON/OFF = 1.5s: 1.5s)

Ambient temperature: Room temperature

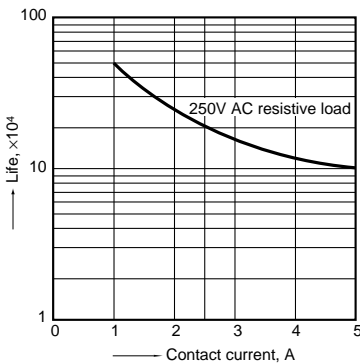

5-(1). Electrical life test  
 (5 A 277 V AC, resistive load)  
 Sample: LKS1aF-12V, 6 pcs.  
 Operation frequency: 20 times/min.  
 (ON/OFF = 1.5s: 1.5s)  
 Ambient temperature: 20°C 68°F

Circuit:

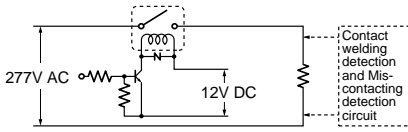

Change of pick-up and drop-out voltage

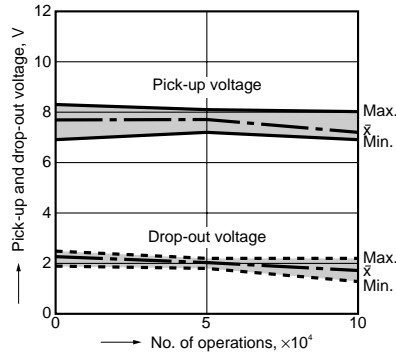

Change of contact resistance

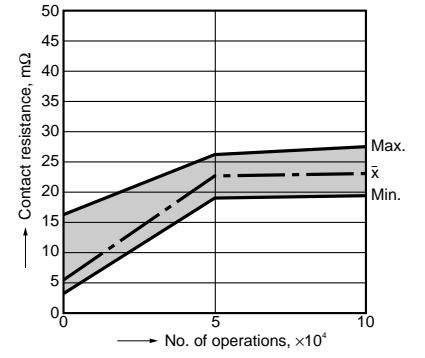

5-(2). Electrical life test (UL lamp load test TV-5)

Tested sample: LKS1aF-12V, 6 pcs.

- Overload test  
 Load: 7.5 A 120 V AC (60 Hz),  
 Inrush: 111 A  
 Operation frequency: 10 times/min  
 (ON: OFF = 1 s: 5 s)  
 No. of operations: 50 ope.
- Endurance test  
 Load: 5A 120 V AC (60 Hz),  
 Inrush: 78 A  
 Operation frequency: 10 times/min  
 (ON: OFF = 1 s: 5 s)  
 No. of operations: 25,000 ope.

Change of pick-up and drop-out voltage

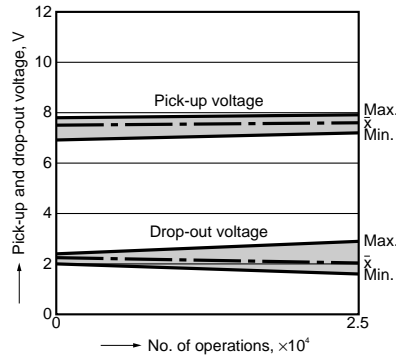

Change of contact resistance

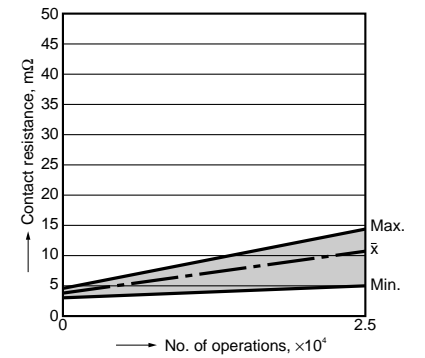

**For Cautions for Use, see Relay Technical Information (Page 11 to 39).**